

Adatlap | Cikkszám: 2010-1204

2 vezetékes átmenő sorkapocs; 10 mm²; Ex e II és Ex i alkalmazáshoz; oldalsó és középső jelölés; DIN 35 x 15 és DIN 35 x 7,5 sínhez; Push-in CAGE CLAMP®; 10,00 mm²; kék

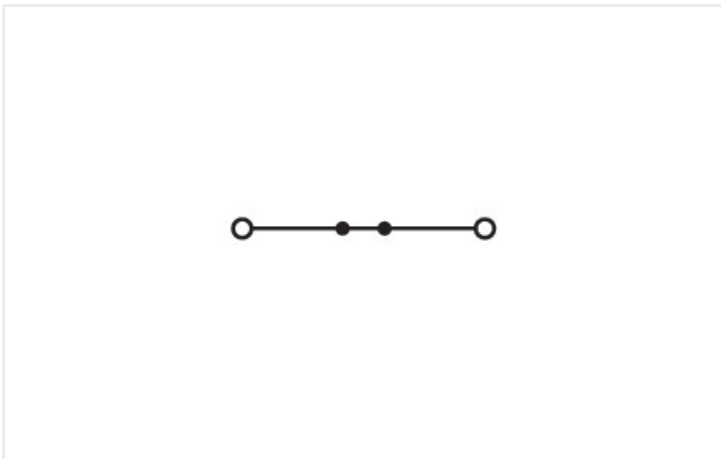
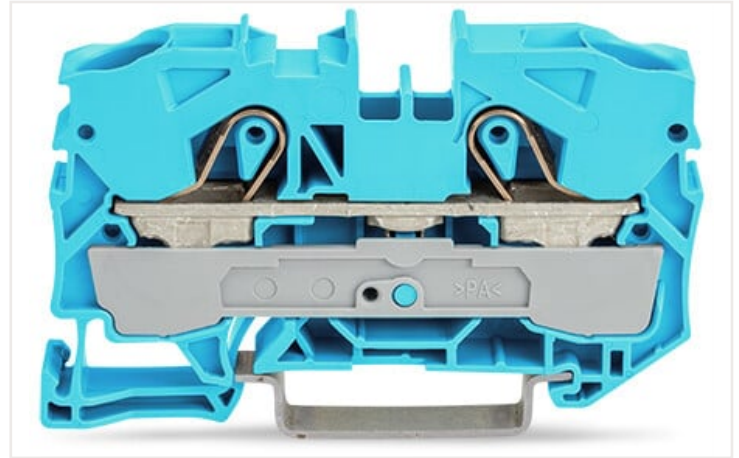
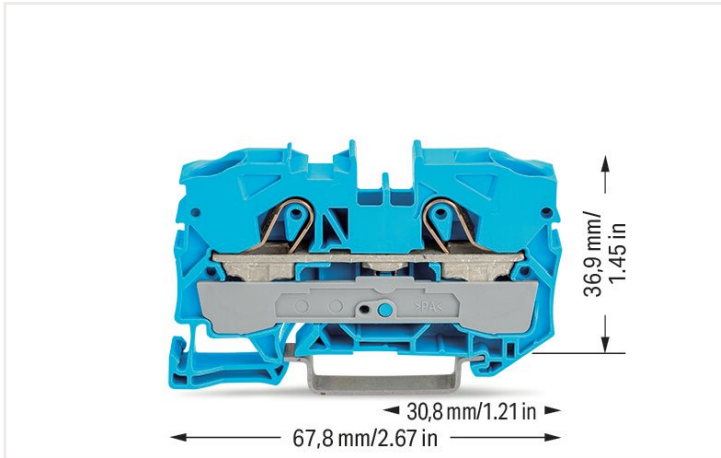

Elektromos adatok

Minősítés az IEC/EN 60664-1 szerint

Értékelés a(z) szerint	IEC/EN 60947-7-1
Névleges feszültség (III / 3)	800 V
Névleges feszültségimpulzus (III / 3)	8 kV
Névleges áram	57 A
Névleges áram (2)	76 A
Jelmagyarázat (néveleges)	(III / 3) \triangleq Túlfeszültség kategória: III / szennyeződési fok 3

Minősítés az UL 1059 szerint

Tanúsított a következők szerint	UL 1059
Névleges feszültség UL esetén (C csoport használata)	600 V
Névleges áram UL (B csoportot használva)	65 A
Névleges feszültség UL (C csoport használata)	600 V
Névleges áram UL (C csoportot használva)	65 A

Minősítés a CSA szerint

Névleges feszültség CSA (B csoport használata esetén)	600 V
Névleges áram CSA (B csoportos használatával)	65 A
Névleges feszültség CSA (C csoport használata)	600 V
Névleges áram CSA (C csoportos használatával)	65 A

Robbanásvédelmi információk

Reference hazardous areas	See installation notes in section "Knowledge" and Downloads – Documentation – Additional Information: Technical Section; Technical explanations
Ratings per	ATEX: PTB 05 ATEX 1070 U / IECEx: PTB 06.0003U (Ex eb IIC Gb)
Névleges feszültség EN (Ex e II)	550 V
Névleges áram (Ex e II)	51 A

Power loss

Power loss, per pole (potential)	1.8194 W
Rated current I_N for specified power loss	57 A
Resistance value for specified, current-dependent power loss	0.00056 Ω

Csatlakozástechnikai adatok

Csatlakozóhelyek száma	2
Potenciálok összes száma	1
Szintek száma	1
Áthidalások száma	2

Connection 1

Csatlakozás-technológia	Push-in CAGE CLAMP®
Beavatkozás típusa	Benyomható Működtető szerszám
Csatlakoztatható vezetékanyagok	Réz
Névleges keresztmetszet	10 mm ²
Tömör vezeték	0,5 ... 16 mm ² / 20 ... 6 AWG
Tömör vezeték, push-in (benyomható) bekötés	4 ... 16 mm ² / 14 ... 6 AWG
Hajlékony vezeték	0,5 ... 16 mm ² / 20 ... 6 AWG
Finom elemiszálás vezeték érvéghüvellyel, műanyag gallérral	0,5 ... 10 mm ² / 20 ... 8 AWG
Finom elemiszálás vezeték érvéghüvellyel, push-in csatlakozással	4 ... 10 mm ² / 12 ... 8 AWG
Megjegyzés (vezeték keresztmetszet)	A vezeték tulajdonságaitól függően kisebb keresztmetszetű vezetéket is lehet csatlakoztatni push-in csatlakoztatással.
Csupaszolási hossz	17 ... 19 mm / 0.67 ... 0.75 inch
Vezetékezési mód	Felső bekötés

Fizikai adatok

Szélesség	10 mm / 0.394 inch
Magasság	67,8 mm / 2.669 inch
Length from upper-edge of DIN-35 rail	36,9 mm / 1.453 inch

Mechanikai adatok

Szerelés típusa	DIN 35 kalapsín
Feliratfelület	Középső/oldalsó jelölés

Anyag információk

Note (material data)	Information on material data can be found here
Szín	kék
Szigetelő anyagcsoport	I
Szigetelő anyaga	Poliamid 66 (PA 66)
UL 94 szerinti gyúlékonysági osztály	V0
Tűzterhelés	0.32 MJ
Tömeg	17.3 g

Környezeti feltételek

Processing temperature	-35 ... +85 °C
Continuous operating temperature	-60 ... +105 °C

Kereskedelmi adatok

Product Group	22 (TOPJOB S)
eCl@ss 10.0	27-14-11-20
eCl@ss 9.0	27-14-11-20
ETIM 8.0	EC000897
ETIM 7.0	EC000897
Csomagolási egység	25 Stück
Csomagolás típusa	Box
Származási ország	DE
EAN/VTSZ	4017332076166
Vámtarifaszám	85369010000

Tanúsítványok / Jóváhagyások

Ex-tanúsítványok



Jóváhagyás	Szabvány	Tanúsítvány neve
AEx UL International Germany GmbH c/o Physikalisch Technische Bundesanstalt	UL 60079	E185892 (Ex e II)
ATEX Physikalisch Technische Bundesanstalt (PTB)	EN 60079	PTB 05 ATEX 1070 U (II 2 G Ex eb II C bzw. I M 2 Ex eb I Mb)
CCCEX CQST/CNEX	CNCA-C23-01	2020312313000161
EAC Brjansker Zertifizierungs- stelle	TP TC 012/2011	RU C-DE.AM02. B.00127/19 (Ex e IIC Gb U)
IECEX Physikalisch Technische Bundesanstalt (PTB)	IEC 60079	IECEX PTB 06.0003 U (Ex eb IIC Gb and Ex ebl Mb)
INMETRO TÜV Rheinland do Brasil Ltda.	IEC 60079	TÜV 12.1311 U

Országspecifikus tanúsítványok



Jóváhagyás	Szabvány	Tanúsítvány neve
CCA DEKRA Certification B.V.	EN 60947	NTR NL 7876
CSA DEKRA Certification B.V.	C22.2 No. 158	70111238
KEMA/KEUR DEKRA Certification B.V.	EN 60947	71-119201

Hajózási tanúsítványok



Jóváhagyás	Szabvány	Tanúsítvány neve
ABS American Bureau of Ship- ping	-	20-HG1941090-PDA
BV Bureau Veritas S.A.	EN 60947	38586/A0 BV
DNV GL Det Norske Veritas, Ger- manischer Lloyd	-	TAE00001V2
LR Lloyds Register	EN 60947	91/20112 (E9)

UL-tanúsítványok



Jóváhagyás	Szabvány	Tanúsítvány neve
UL UL International Germany GmbH	UL 1059	E45172

Letöltések

Environmental Product Compliance

Compliance Search

Environmental Product Compliance 2010-1204



Documentation

Additional Information

Technical Section

pdf
2142.18 KB



Bid Text

2010-1204	17.04.2019	xml 3.96 KB	
2010-1204	17.04.2019	docx 14.83 KB	

CAD/CAE-Data

CAD data

2D/3D Models
2010-1204



CAE data

EPLAN Data Portal
2010-1204



WSCAD Universe
2010-1204



ZUKEN Portal
2010-1204



Szerelési útmutató

Vezetékbekötés

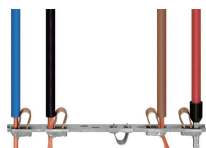

All conductor types at a glance

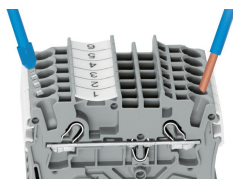

Push-in termination of solid and ferruled conductors

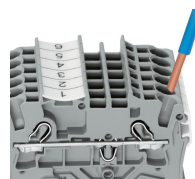

Inserting a conductor via push-in termination:
Solid conductors with cross-sections from either one size above, or up to two sizes below, the rated cross-section can be simply pushed in – no tools needed.

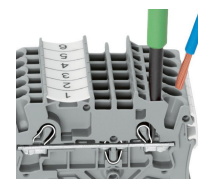

Inserting a conductor via operating tool:
Connecting fine-stranded conductors without ferrules, or small cross-sectional conductors that cannot be pushed in, is performed similarly to the original CAGE CLAMP® – just use an operating tool.
Advantage:
To open the clamp, the operating tool is inserted vertically. The conductor entry is less than 15 degrees for easier wiring.

Összekötés

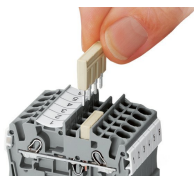

Insert push-in type jumper bar and push down until it hits backstop.

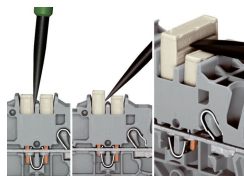

Removing a push-in type jumper bar: Insert the operating tool between the jumper and partition wall of the dual jumper slots, then lift up the jumper. Place the operating tool in the center of jumpers for up to five contacts (see above), or alternately on both sides for jumpers with more than five contacts.

Összekötés

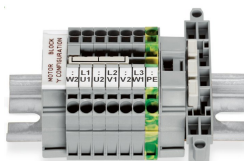

This star point jumper has been specially developed to create a "star point" and is used on motor terminal boards equipped with Rail-Mount Terminal Blocks TOPJOB® S.

Összekötés

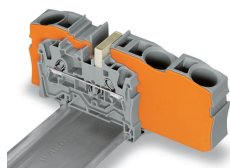

Step-down jumpers common terminal blocks of different sizes, without losing a conductor clamping point. This can be beneficial on long conductor runs where voltage drop can be a problem. A large conductor can be easily connected to smaller conductors at the distribution point. Commoning may be made in either direction using the special thin end plate to cover the open side. Additional through terminal blocks having a smaller cross-section may be commoned using push-in type jumper bars.

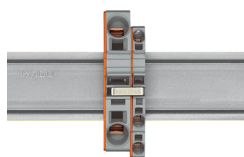

Using step-down jumpers, an end plate must be inserted between the terminal blocks to be commoned.



Step-down jumper (2006-499) commons 6/4 mm² (10/12 AWG) terminal blocks (2006/2004 Series) with 4/2.5/1.5 mm² (AWG 12/14/16) terminal blocks (2004/2002/2001 Series).

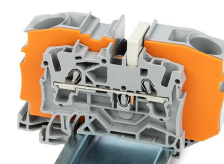

Step-down jumper (2016-499) commons 16/10 mm² (16/8 AWG) terminal blocks (2016/2010 Series) with 10/6/4/2.5 mm² (8/10/12/14 AWG) terminal blocks (2010/2006/2004/2002 Series).

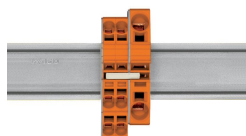

Stepping down via push-in type jumper bar: Commoning via open terminal side with end plate allows jumpering over two cross-section sizes for 16 mm² (6 AWG) and 10 mm² (8 AWG) and one cross-section size for 6/4/2.5 mm² (10/12/14 AWG). An example: from 16 mm² (6 AWG) to 6 mm² (10 AWG) (see illustration above) or from 10 mm² (8 AWG) to 4 mm² (12 AWG).

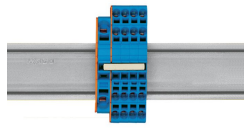

Stepping down via push-in type jumper bar: Commoning via closed terminal side with end plate allows jumpering over two cross-section sizes, e.g., from 16 mm² (6 AWG) to 6 mm² (10 AWG) or from 6 mm² (10 AWG) to 2.5 mm² (14 AWG) (see illustration above).

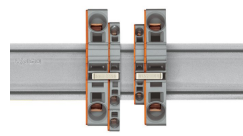

Note: The total current of the outgoing circuits must not exceed the nominal current of the step-down jumper/push-in type jumper bar.

Ellenőrzés

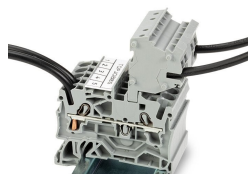

The modular TOPJOB® S connectors also connect conductors of the same size as the terminal blocks being used.

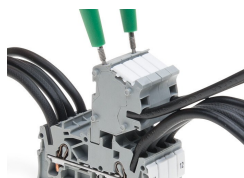

TOPJOB® S Connectors with a 2 mm Ø test socket for testing voltage via 2-pole voltage tester

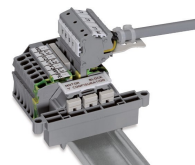

Rail-mount terminal block assembly for electric motor wiring



Test plug adapter (2009-174, CAT I) for 4 mm Ø plugs – compatible with 2000 to 2016 Series



Testing tap (2009-182) for tool-free connection of test cables up to 2.5 mm² (12 AWG) – compatible with 2000 to 2016 Series

Jelölés

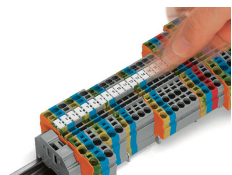

Snapping WMB Inline markers into marker slots.

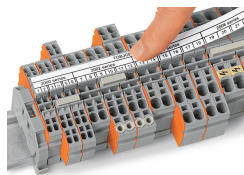

TOPJOB® S 2009-193 Group Marker Carrier (equipped with a marking strip) for all 2001 to 2016 Series TOPJOB® S Rail-Mount Terminal Blocks
Do not use on an end plate!



Fokozott biztonságú (Ex) alkalmazás



Through terminal blocks with a blue insulated housing are suitable for Ex i applications.

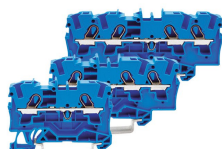

All through and ground conductor terminal blocks are suitable for Ex e II applications.

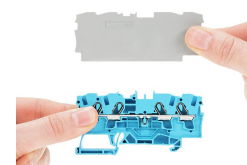

Separator plate for Ex e/Ex i applications
An end plate must be applied to the terminal block located directly behind an Ex e/Ex i separator plate.



Ex e II/Ex i terminal strip
Note:
The movable feet of terminal blocks and separator plates must face the same direction.

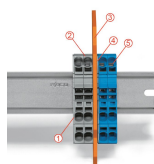

A separator plate is located between the Ex e II and Ex i terminal strip.
End plate
Ex e II terminal blocks
Separator plate for Ex e/Ex i applications
End plate
Ex i terminal blocks
According to EN 50020, a minimum distance of 50 mm must be kept between live parts of Ex e and Ex i circuits. The use of Ex e/Ex i separators is a space-saving solution when Ex e and Ex i terminal blocks are mounted on a common DIN-rail.

A változtatás jogát fenntartjuk. Kérjük, figyelmesen olvassa el a további termékdokumentációkat is!

A jelenleg érvényes címek itt találhatóak: www.wago.com