



INSTALLATION GUIDE

ENGLISH

Code: **ARAD3S**

Name: **RACK 3U/270mm universal enclosure
for RACK 19" cabinets**

Metallic enclosure for RACK cabinet: CCTV, KD, SSWiN, RTV, LAN

IM ARAD3S

IP20

RoHS

Edition: 1 from 20.03.2017
Supersedes: -----

EN

1. Intended use:

Due to its design, the ARAD3S enclosure is intended for mounting inside RACK 19" cabinets. This general-purpose enclosure may serve as an auxiliary element for integrating CCTV, AC, I&HAS, RTV, LAN systems in RACK 19" cabinets. It is intended for mounting alarm control panels, AC controllers, power supply units, batteries, etc.

2. Description

The enclosure is equipped with a mounting plate for mounting electronics/transformers/power supply units. The enclosure can accommodate a 17Ah/12V battery and it features tampering protection (against unwanted opening). To enable leading cables into the enclosure, one can buy a cable protection conduit of any length and a cable gland. The conduits and the cable glands are available at the following codes:

- 1) **ARAP16P** – cable gland, inside diameter 16 mm – connection between the protection conduit and the enclosure
- 2) **ARAP21P** – cable gland, inside diameter 21 mm – connection between the protection conduit and the enclosure
- 3) **MM019** – cable protection conduit, inside diameter 16 mm
- 4) **MM020** – cable protection conduit, inside diameter 21 mm

The **ARAD3S** enclosure has a space for up to 2x ARAP16P and 5x ARAP21P cable glands.

Optionally, **ARAW45** fans can be mounted. They trigger airflow inside the enclosure after exceeding 45°C. One enclosure can accommodate max. two fan units in the rear part of the enclosure.



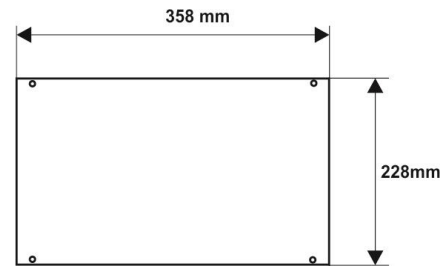
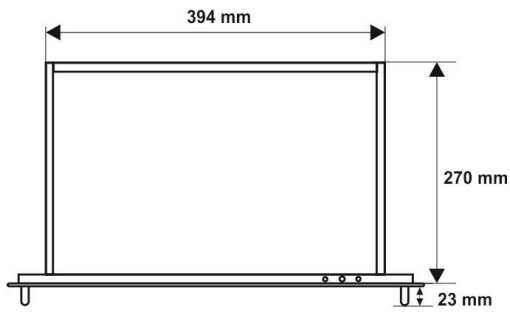
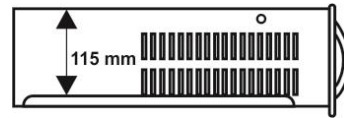
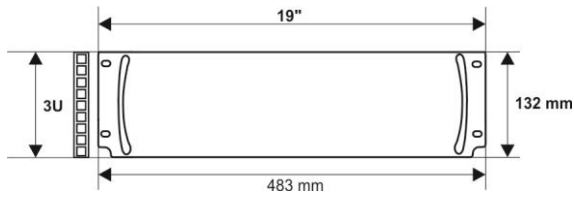
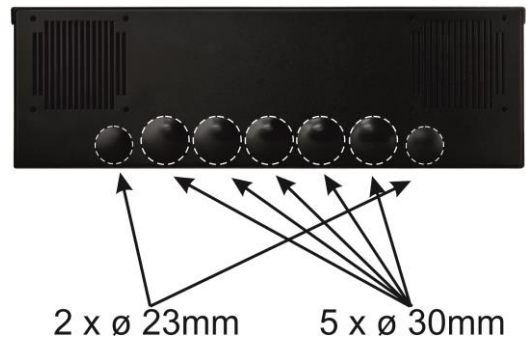
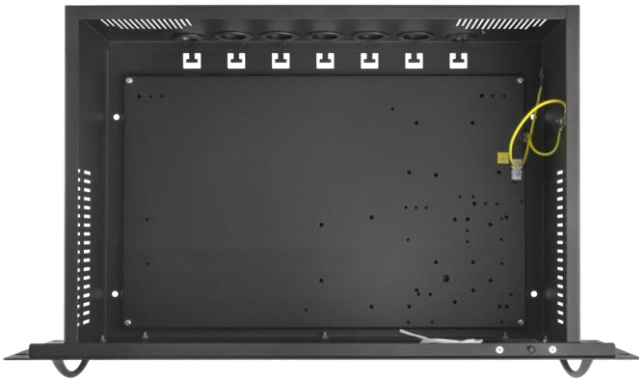

Dimensions of the mounting plate

3. Assembling instructions:

The ARAD3S enclosure can be mounted in two ways:

1. Mounting without the ARAS450 rails, no extension slide, the front part is the load-bearing part of the enclosure. This method of installation is dedicated for economic versions with a load capacity of up to 5 kg.

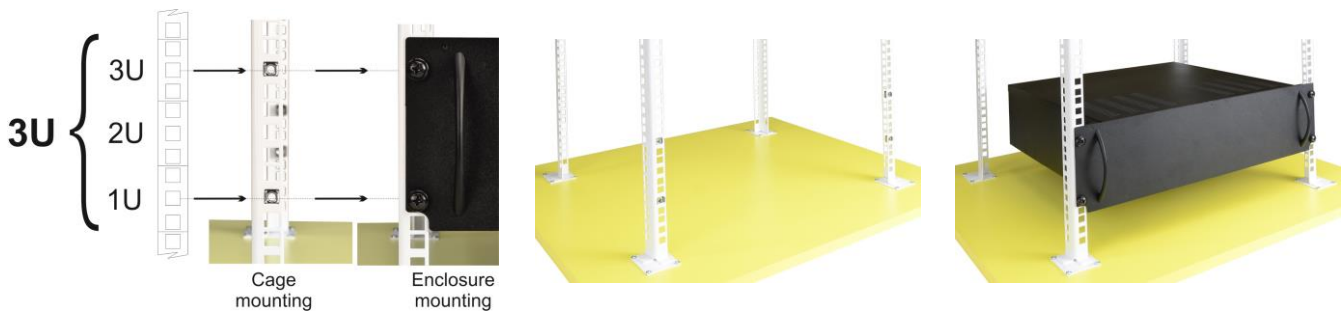

2. Mounting with the ARAS450 rails - full extension slide of the RACK cabinet, rails of the ARAS450 series are the load-bearing part of the enclosure. Dedicated for up to 30kg load.

2.1. Mount cage nuts for M6 screws in the RACK cabinet, as shown in Figure below, and mount the ARAS450 rails. Make sure that the rail is correctly mounted horizontally and its length between the front and rear RACK profile is properly adjusted.

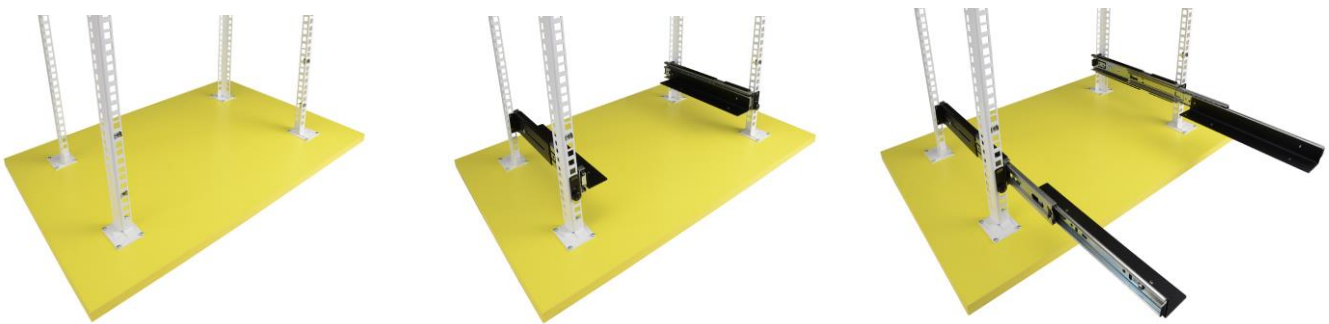
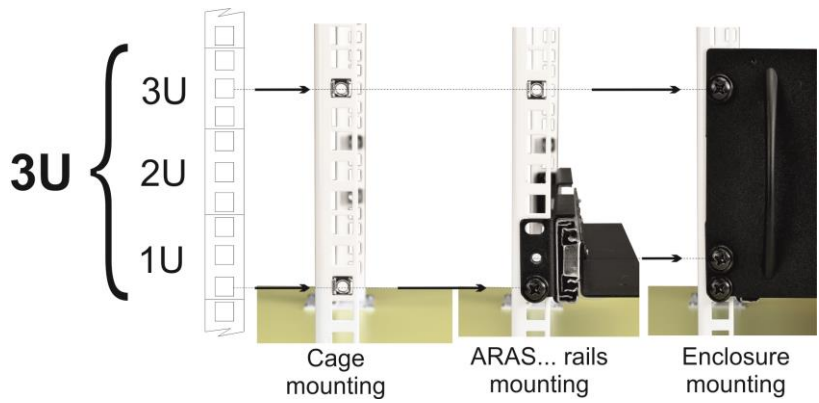

2.2. Mount the ARAD enclosure on fully extended ARAS rails using 6xM4 screws (complete with ARAS rails). Tighten the screws from the inside. The enclosure is mounted in the front of the RACK rails - using 4xM6 screws.



4. Accessories:

**Power supplies PS.../PSB.../PSBOC... series
Transformers of the following series TOR/TRP/TRZ**

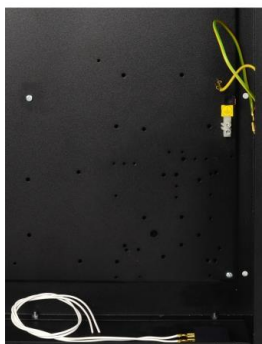

Empty mounting plate

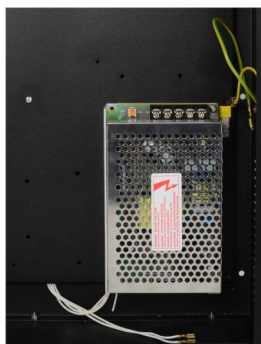

Empty mounting PS., PSB., PSBOC.. series



Enclosed power supply units TOR... series



Transformers TRP... series



Transformers TRZ 20/40 series

The ARAW45 fan

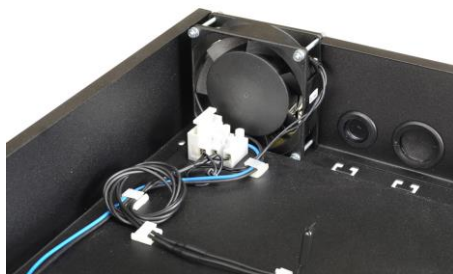
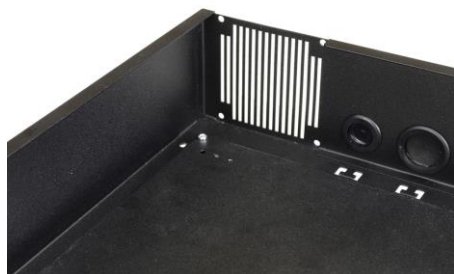

Cable glands and protection tubes

Wires can be introduced in three ways:

- Through rubber grommets,
- Using the MM019/MM020 protection tubes,
- Using the MM019/MM020 protection tubes and the ARAP16P/ARAP21P cable glands.

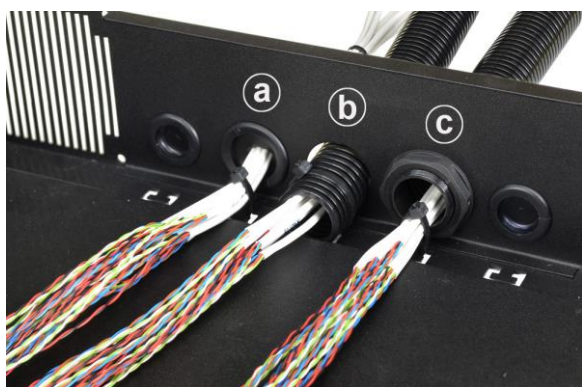

5. Specifications

SPECIFICATIONS	
Fitting battery	17Ah/12V
Tampering protection	1x – against unwanted opening of the enclosure
Max. load of TAMPER output	500mA@50VDC
Enclosure: IP	IP 20
Operation temperature	-10°C ÷ 40°C
Relative humidity RH – max.	90 [%]
Internal dimensions (W x H x D)	390 x 115 x 265 [- / +2] [mm]
Materials	Sheet metal DC01, 1,0mm thick + front panel thickness: 1,5mm Rust protection Colour: RAL 9005 BLACK
Use	inside
Net weight	~4,40 [kg]
Gross weight	~4,95 [kg]
Declarations, warranty	CE, 2 year from the production date

PRODUCENT / PRODUCER

Pulsar
 Siedlec 150,
 32-744 Łapczyca, Poland
 Tel. (+48) 14-610-19-40, Fax. (+48) 14-610-19-50
 e-mail: biuro@pulsar.pl, sales@pulsar.pl
[http:// www.pulsar.pl](http://www.pulsar.pl), www.zasilacze.pl