

CODE: RAC188 v1.0/I
 NAME: Plinth 100mm for floor standing cabinets 800x800mm

EN

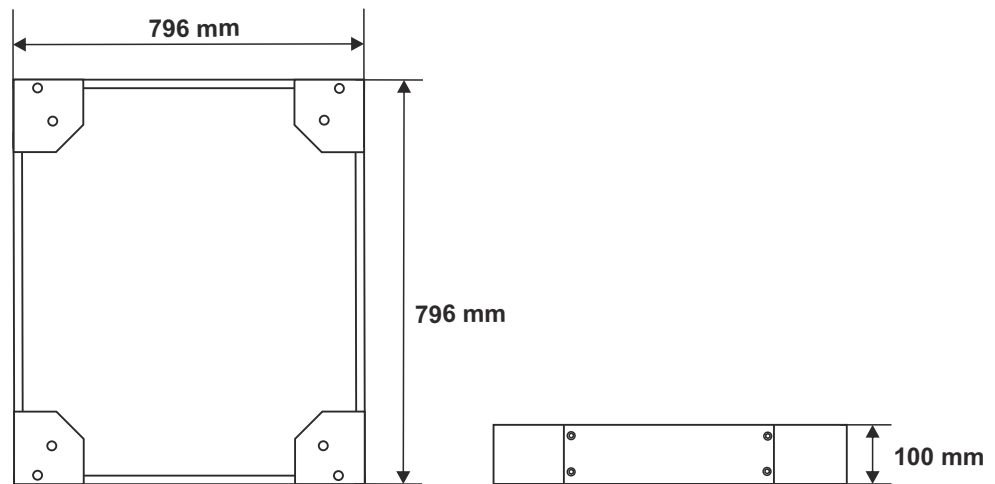

INTENDED USE

The 100mm plinth is intended for 800x800mm floor standing cabinets. It enables stabilising the cabinet and fixing it to the floor.

SPECIFICATIONS

Dimensions:	W=796, H=100, D=796 [mm, +/-2]
Net/gross weight:	5,8 / 6,5 [kg]
Materials:	1,2 and 2mm cold-rolled steel (SPCC), RAL 9004
Use:	inside
Notes:	- mounted to the bottom of a RACK cabinet - 4 M12 screws (hex socket head) + washers included