

Adatlap | Cikkszám: 2002-1204

2 vezetékes átmenő sorkapocs; 2,5 mm²; Ex e II és Ex i alkalmazáshoz; oldalsó és középső jelölés; DIN 35 x 15 és DIN 35 x 7,5 sínhez; Push-in CAGE CLAMP®; 2,50 mm²; kék

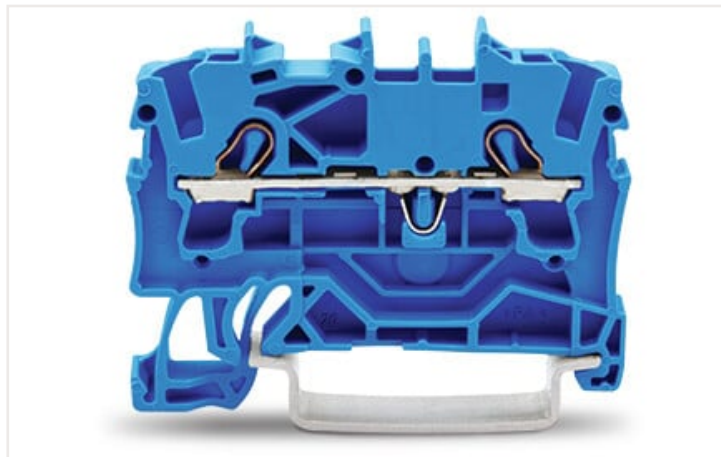
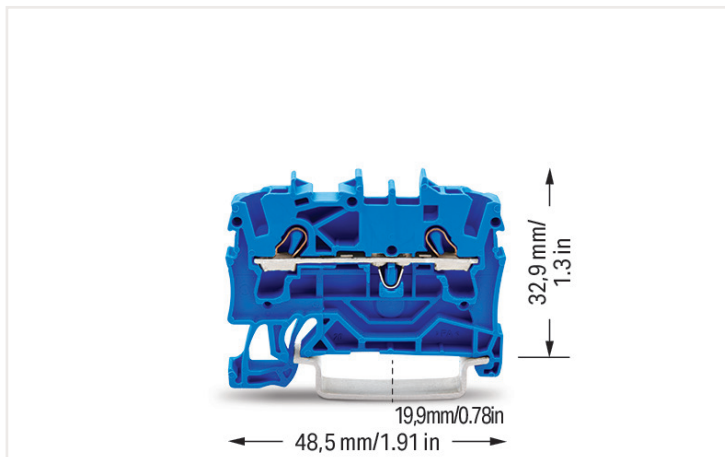

Elektromos adatok

Minősítés az IEC/EN 60664-1 szerint

Értékelés a(z) szerint	IEC/EN 60947-7-1
Névleges feszültség (III / 3)	800 V
Névleges feszültségimpulzus (III / 3)	8 kV
Névleges áram	24 A
Névleges áram (2)	32 A
Jelmagyarázat (néveleges)	(III / 3) ≙ Túlfeszültség kategória: III / szennyeződési fok 3

Minősítés az UL 1059 szerint

Tanúsított a következők szerint	UL 1059
Névleges feszültség UL esetén (C csoport használata)	600 V
Névleges áram UL (B csoportot használva)	20 A
Névleges feszültség UL (C csoport használata)	600 V
Névleges áram UL (C csoportot használva)	20 A

Minősítés a CSA szerint

Tanúsított a következők szerint	CSA 22.2 No 158
Névleges feszültség CSA (B csoport használata esetén)	600 V
Névleges áram CSA (B csoport használatával)	20 A
Névleges feszültség CSA (C csoport használata)	600 V
Névleges áram CSA (C csoport használatával)	20 A

Power loss

Power loss, per pole (potential)	0.7661 W
Rated current I_N for specified power loss	24 A
Resistance value for specified, current-dependent power loss	0.00133 Ω

Robbanásvédelmi információk

Reference hazardous areas	See installation notes in section "Knowledge" and Downloads – Documentation – Additional Information: Technical Section; Technical explanations
Ratings per	ATEX: PTB 03 ATEX 1162 U / IECEx: PTB 03.0004U (Ex eb IIC Gb)
Névleges feszültség EN (Ex e II)	550 V
Névleges áram (Ex e II)	22 A
Névleges áram (Ex e II) áthidalóval	20 A

Csatlakozástechnikai adatok

Csatlakozóhelyek száma	2
Potenciálok összes száma	1
Szintek száma	1
Áthidalások száma	2

Connection 1

Csatlakozás-technológia	Push-in CAGE CLAMP®
Beavatkozás típusa	Benyomható Működtető szerszám
Csatlakoztatható vezetékanyagok	Réz
Névleges keresztmetszet	2,5 mm ²
Tömör vezeték	0,25 ... 4 mm ² / 22 ... 12 AWG
Tömör vezeték, push-in (benyomható) bekötés	0,75 ... 4 mm ² / 18 ... 12 AWG
Hajlékony vezeték	0,25 ... 4 mm ² / 22 ... 12 AWG
Finom elemiszálás vezeték érvéghüvellyel, műanyag gallérral	0,25 ... 2,5 mm ² / 22 ... 14 AWG
Finom elemiszálás vezeték érvéghüvellyel, push-in csatlakozással	1 ... 2,5 mm ² / 18 ... 14 AWG
Megjegyzés (vezeték keresztmetszet)	A vezeték tulajdonságaitól függően kisebb keresztmetszetű vezetéket is lehet csatlakoztatni push-in csatlakoztatással.
Csupaszolási hossz	10 ... 12 mm / 0.39 ... 0.47 inch
Vezetékezési mód	Felső bekötés

Fizikai adatok

Szélesség	5,2 mm / 0.205 inch
Magasság	48,5 mm / 1.909 inch
Length from upper-edge of DIN-35 rail	32,9 mm / 1.295 inch

Mechanikai adatok

Szerelés típusa	DIN 35 kalapsín
Feliratfelület	Középső/oldalsó jelölés

Anyag információk

Note (material data)	Information on material data can be found here
Szín	kék
Szigetelő anyagcsoport	I
Szigetelő anyaga	Poliamid 66 (PA 66)
UL 94 szerinti gyúlékonysági osztály	V0
Tűzterhelés	0.109 MJ
Tömeg	4.9 g

Környezeti feltételek

Processing temperature	-35 ... +85 °C
------------------------	----------------

Kereskedelmi adatok

Product Group	22 (TOPJOB S)
eCl@ss 10.0	27-14-11-20
eCl@ss 9.0	27-14-11-20
ETIM 8.0	EC000897
ETIM 7.0	EC000897
Csomagolási egység	100 Stück
Csomagolás típusa	Box
Származási ország	DE
EAN/VTSZ	4017332999175
Vámtarifaszám	85369010000

Tanúsítványok / Jóváhagyások

Ex-tanúsítványok



Jóváhagyás	Szabvány	Tanúsítvány neve
AEx Underwriters Laboratories Inc.	UL 60079	E185892 (AEx eb IIC resp. Ex eb IIC)
ATEX Physikalisch Technische Bundesanstalt (PTB)	EN 60079	PTB 03 ATEX 1162 U (II 2 G Ex eb IIC Gb bzw. I M 2 Ex eb I Mb)
CCCEX CQST/CNEX	CNCA-C23-01	2020312313000238
EAC Brjansker Zertifizierungsstelle	TP TC 012/2011	RU C-DE.AM02. B.00127/19 (Ex e IIC Gb U)
IECEX Physikalisch Technische Bundesanstalt	IEC 60079	IECEX PTB 03.0004U (Ex eb IIC Gb or Ex eb I Mb)

Országspecifikus tanúsítványok



Jóváhagyás	Szabvány	Tanúsítvány neve
CCA DEKRA Certification B.V.	EN 60947	71-120369
CCA DEKRA Certification B.V.	EN 60947	NTR NL 7892
CCA DEKRA Certification B.V.	C22.2 No. 158	1536069

Hajózási tanúsítványok



Jóváhagyás	Szabvány	Tanúsítvány neve
ABS American Bureau of Shipping	EN 60947	20-HG1941090-PDA
BV Bureau Veritas S.A.	EN 60947	38586/A0 BV

Hajózási tanúsítványok

DNV GL Det Norske Veritas, Germanischer Lloyd	-	TAE00001V2
LR Lloyds Register	EN 60947	91/20112 (E9)

UL-tanúsítványok



Jóváhagyás	Szabvány	Tanúsítvány neve
UL Underwriters Laboratories Inc.	UL 1059	E45172

Letöltések

Environmental Product Compliance

Compliance Search

Environmental Product
Compliance 2002-1204

Documentation

Additional Information

Technical Section

pdf
2142.18 KB

Bid Text

2002-1204

29.04.2019

xml
4.17 KB

2002-1204

23.04.2019

docx
14.78 KB

CAD/CAE-Data

CAD data

2D/3D Models
2002-1204

CAE data

EPLAN Data Portal
2002-1204WSCAD Universe
2002-1204ZUKEN Portal
2002-1204

Szerelési útmutató

Vezetékbekötés



All conductor types at a glance

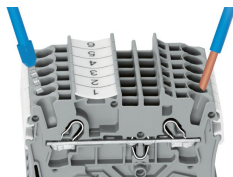

Push-in termination of solid and ferruled conductors

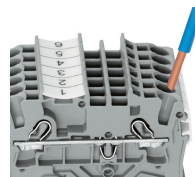

Inserting a conductor via push-in termination:
Solid conductors with cross-sections from either one size above, or up to two sizes below, the rated cross-section can be simply pushed in – no tools needed.

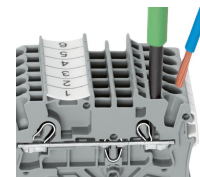

Inserting a conductor via operating tool:
Connecting fine-stranded conductors without ferrules, or small cross-sectional conductors that cannot be pushed in, is performed similarly to the original CAGE CLAMP® – just use an operating tool.
Advantage:
To open the clamp, the operating tool is inserted vertically. The conductor entry is less than 15 degrees for easier wiring.

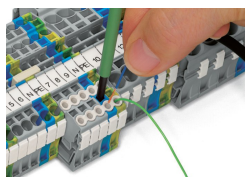

Conductor termination – insulation stop

Összekötés

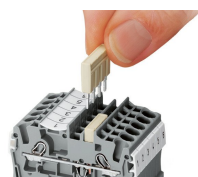

Insert push-in type jumper bar and push down until it hits backstop.

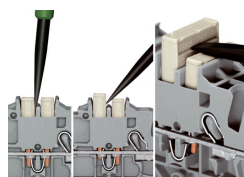

Removing a push-in type jumper bar:
Insert the operating tool between the jumper and partition wall of the dual jumper slots, then lift up the jumper.
Place the operating tool in the center of jumpers for up to five contacts (see above), or alternately on both sides for jumpers with more than five contacts.

Összekötés



Orient the staggered jumpers' red stripes on the inside.
Insert the staggered jumper and push down until it hits the backstop.

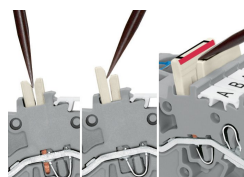

Removing a staggered jumper:
Insert the operating tool between the staggered jumpers, then lift up the jumper.

Összekötés

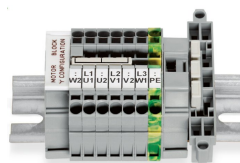
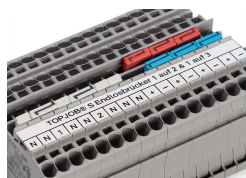

Continuous jumpers (2002 Series) readily connect an endless number of terminal blocks to each other via single jumper slot. Use the second jumper slot for additional commoning or testing.

The 1-to-3 adjacent jumper for continuous commoning enables every other terminal block to be commoned. For example, positive and negative potentials can be accommodated alongside each other.

This star point jumper has been specially developed to create a "star point" and is used on motor terminal boards equipped with Rail-Mount Terminal Blocks TOPJOB® S.

This delta jumper has been specially developed to create a delta configuration and is used on motor terminal boards equipped with rail-mount terminal blocks TOPJOB® S.

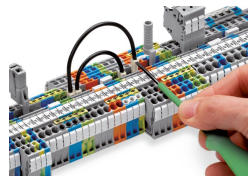

Push down the wire jumper until fully inserted. Lift the jumper with an operating tool for rewiring.

Összekötés

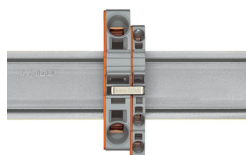
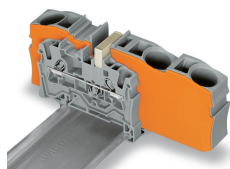

Step-down jumpers common terminal blocks of different sizes, without losing a conductor clamping point. This can be beneficial on long conductor runs where voltage drop can be a problem. A large conductor can be easily connected to smaller conductors at the distribution point. Commoning may be made in either direction using the special thin end plate to cover the open side. Additional through terminal blocks having a smaller cross-section may be commoned using push-in type jumper bars.

Using step-down jumpers, an end plate must be inserted between the terminal blocks to be commoned.

Step-down jumper (2006-499) commons 6/4 mm² (10/12 AWG) terminal blocks (2006/2004 Series) with 4/2.5/1.5 mm² (AWG 12/14/16) terminal blocks (2004/2002/2001 Series).

Step-down jumper (2016-499) commons 16/10 mm² (16/8 AWG) terminal blocks (2016/2010 Series) with 10/6/4/2.5 mm² (8/10/12/14 AWG) terminal blocks (2010/2006/2004/2002 Series).

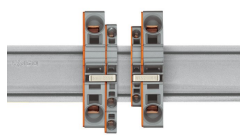
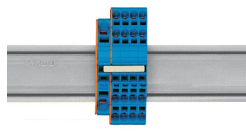
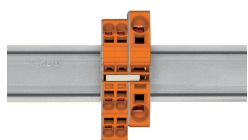

Stepping down via push-in type jumper bar: Commoning via open terminal side with end plate allows jumpering over two cross-section sizes for 16 mm² (6 AWG) and 10 mm² (8 AWG) and one cross-section size for 6/4/2.5 mm² (10/12/14 AWG). An example: from 16 mm² (6 AWG) to 6 mm² (10 AWG) (see illustration above) or from 10 mm² (8 AWG) to 4 mm² (12 AWG).

Stepping down via push-in type jumper bar: Commoning via closed terminal side with end plate allows jumpering over two cross-section sizes, e.g., from 16 mm² (6 AWG) to 6 mm² (10 AWG) or from 6 mm² (10 AWG) to 2.5 mm² (14 AWG) (see illustration above).

Note: The total current of the outgoing circuits must not exceed the nominal current of the step-down jumper/push-in type jumper bar.

Ellenőrzés

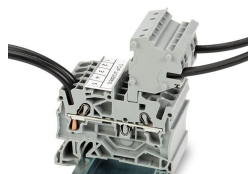

The modular TOPJOB® S connectors also connect conductors of the same size as the terminal blocks being used.

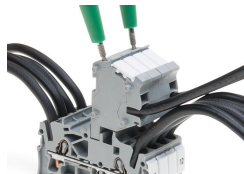

TOPJOB® S Connectors with a 2 mm Ø test socket for testing voltage via 2-pole voltage tester

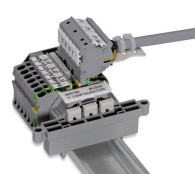

Rail-mount terminal block assembly for electric motor wiring

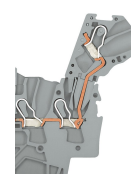

L-type test plug module – cross-sectional view of contacts



Test plug adapter (2009-174, CAT I) for 4 mm Ø plugs – compatible with 2000 to 2016 Series



Testing tap (2009-182) for tool-free connection of test cables up to 2.5 mm² (12 AWG) – compatible with 2000 to 2016 Series

Jelölés

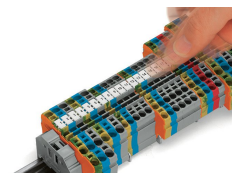

Snapping WMB Inline markers into marker slots.

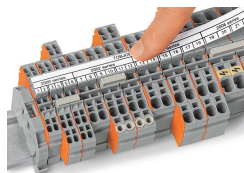

TOPJOB® S 2009-193 Group Marker Carrier (equipped with a marking strip) for all 2001 to 2016 Series TOPJOB® S Rail-Mount Terminal Blocks
Do not use on an end plate!



Using marker carriers for marking strips (2002-161) in jumper slots.

Fokozott biztonságú (Ex) alkalmazás

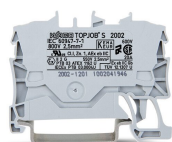

Through terminal blocks with a blue insulated housing are suitable for Ex i applications.

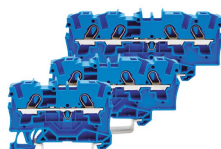

All through and ground conductor terminal blocks are suitable for Ex e II applications.

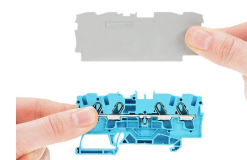
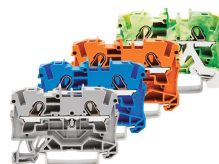

Separator plate for Ex e/Ex i applications
An end plate must be applied to the terminal block located directly behind an Ex e/Ex i separator plate.



Ex e II/Ex i terminal strip
Note:
The movable feet of terminal blocks and separator plates must face the same direction.

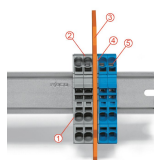

A separator plate is located between the Ex e II and Ex i terminal strip.
End plate
Ex e II terminal blocks
Separator plate for Ex e/Ex i applications
End plate
Ex i terminal blocks
According to EN 50020, a minimum distance of 50 mm must be kept between live parts of Ex e and Ex i circuits. The use of Ex e/Ex i separators is a space-saving solution when Ex e and Ex i terminal blocks are mounted on a common DIN-rail.

A változtatás jogát fenntartjuk. Kérjük, figyelmesen olvassa el a további termékdokumentációkat is!

A jelenleg érvényes címek itt találhatóak: www.wago.com